

T885 PCB Layout - Bottom Side
220-01595-02

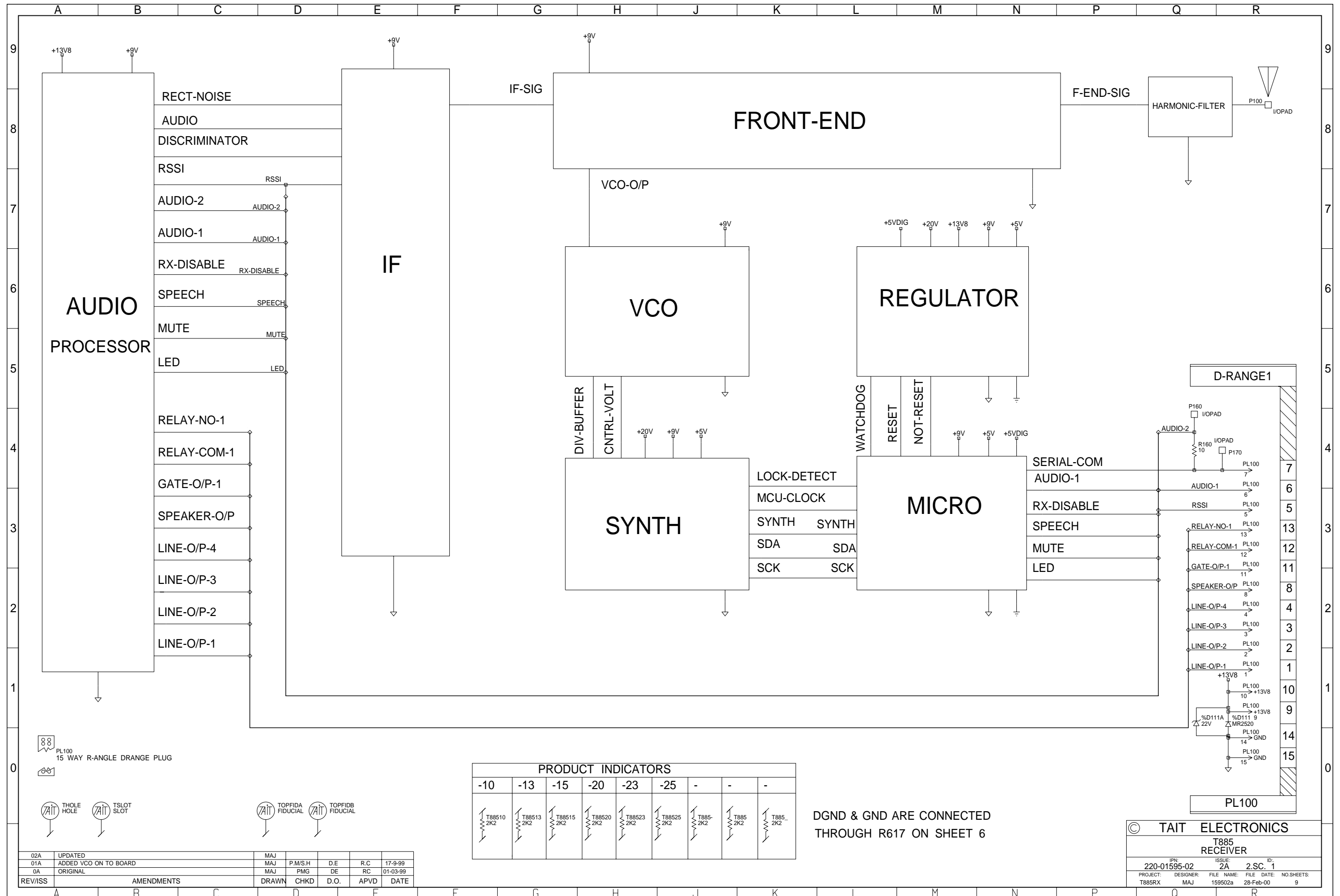

PL100
15 WAY R-ANGLE DRANGE PLUG

THOLE HOLE
 TSL0T SLOt
 TOPFIDA FIDUCIAL
 TOPFIDB FIDUCIAL

PRODUCT INDICATORS								
-10	-13	-15	-20	-23	-25	-	-	-
T88510 2K2	T88513 2K2	T88515 2K2	T88520 2K2	T88523 2K2	T88525 2K2	T885- 2K2	T885- 2K2	T885- 2K2

DGND & GND ARE CONNECTED THROUGH R617 ON SHEET 6

© TAIT ELECTRONICS			
T885 RECEIVER			
IPN:	ISSUE:	2A	2.S.C. 1
PROJECT:	DESIGNER:	FILE NAME:	FILE DATE:
T885RX	MAJ	159502a	28-Feb-00
NO. SHEETS:	9		

02A	UPDATED	MAJ					
01A	ADDED VCO ON TO BOARD	MAJ	P.M/S.H	D.E	R.C	17-9-99	
0A	ORIGINAL	MAJ	PMG	DE	RC	01-03-99	
REV/ISS	AMENDMENTS	DRAWN	CHKD	D.O.	APVD	DATE	

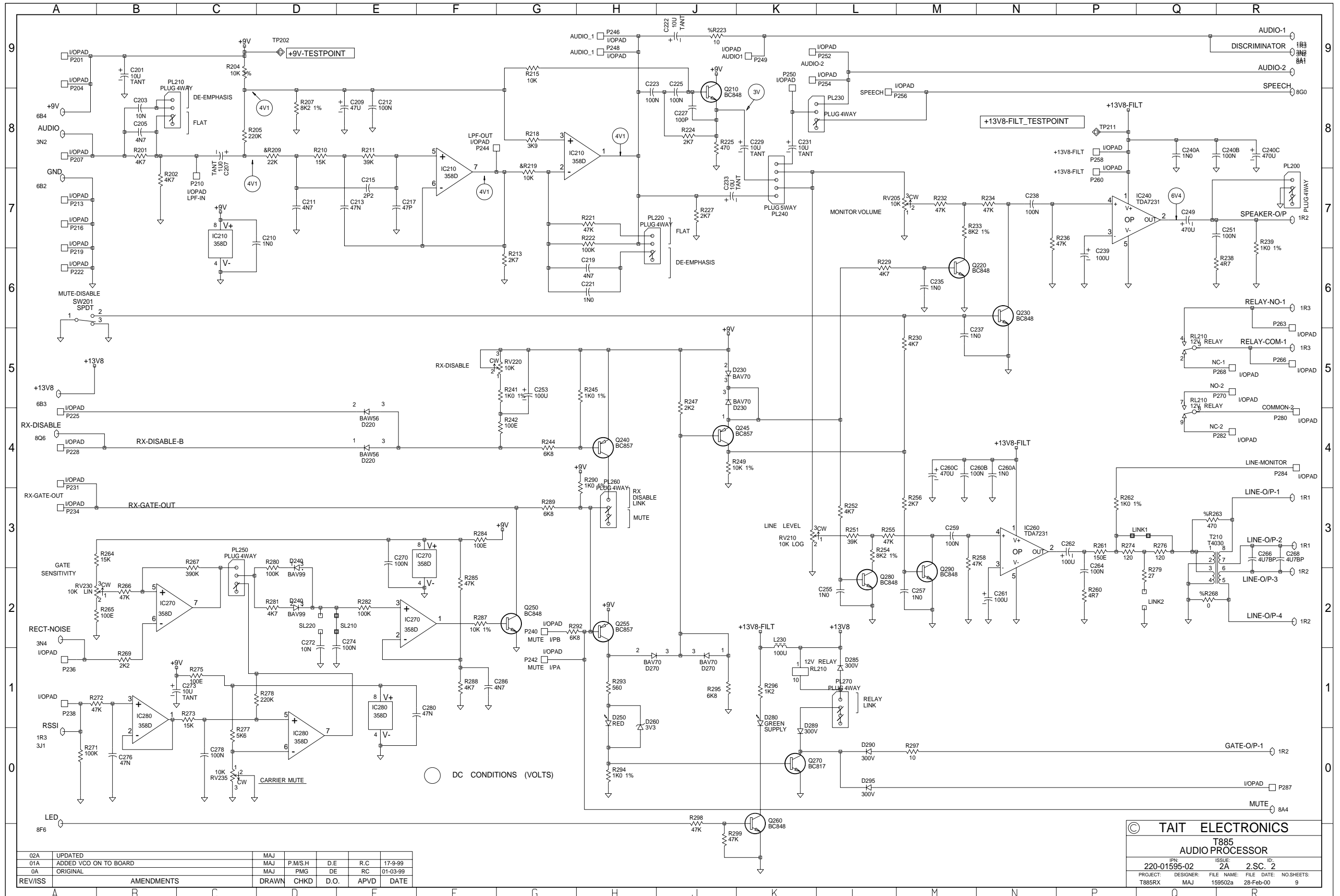

Q2A	UPDATED	MAJ				
Q1A	ADDED VCO ON TO BOARD	MAJ	P.M/S.H	D.E	R.C	17-9-99
Q0A	ORIGINAL	MAJ	PMG	DE	RC	01-03-99
REV/ISS	AMENDMENTS	DRAWN	CHKD	D.O.	APVD	DATE

© TAIT ELECTRONICS
T885 AUDIO PROCESSOR

IPN	ISSUE	ID
220-01595-02	2A	2.S.C. 2
PROJECT: T885RX	DESIGNER: MAJ	FILE NAME: 159502a
		FILE DATE: 28-Feb-00
		NO.SHEETS: 9

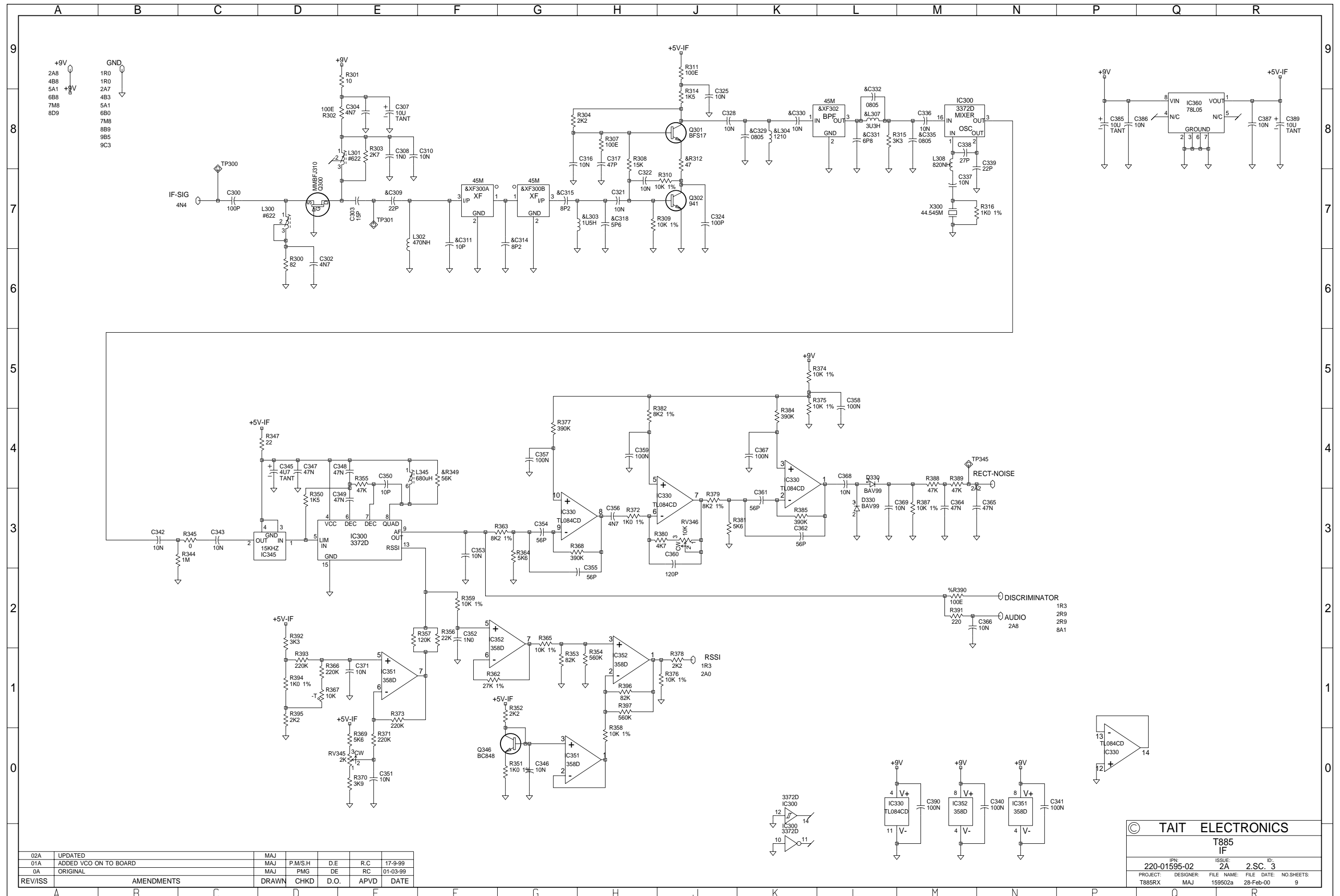

02A	UPDATED	MAJ				
01A	ADDED VCO ON TO BOARD	MAJ	P.M/S.H	D.E	R.C	17-9-99
0A	ORIGINAL	MAJ	PMG	DE	RC	01-03-99
REV/ISS	AMENDMENTS	DRAWN	CHKD	D.O.	APVD	DATE

© TAIT ELECTRONICS			
T885 IF			
IPN:	ISSUE:	2A	ID: 2.S.C. 3
PROJECT:	DESIGNER:	FILE NAME:	FILE DATE:
T885RX	MAJ	159502a	28-Feb-00
			NO SHEETS: 9

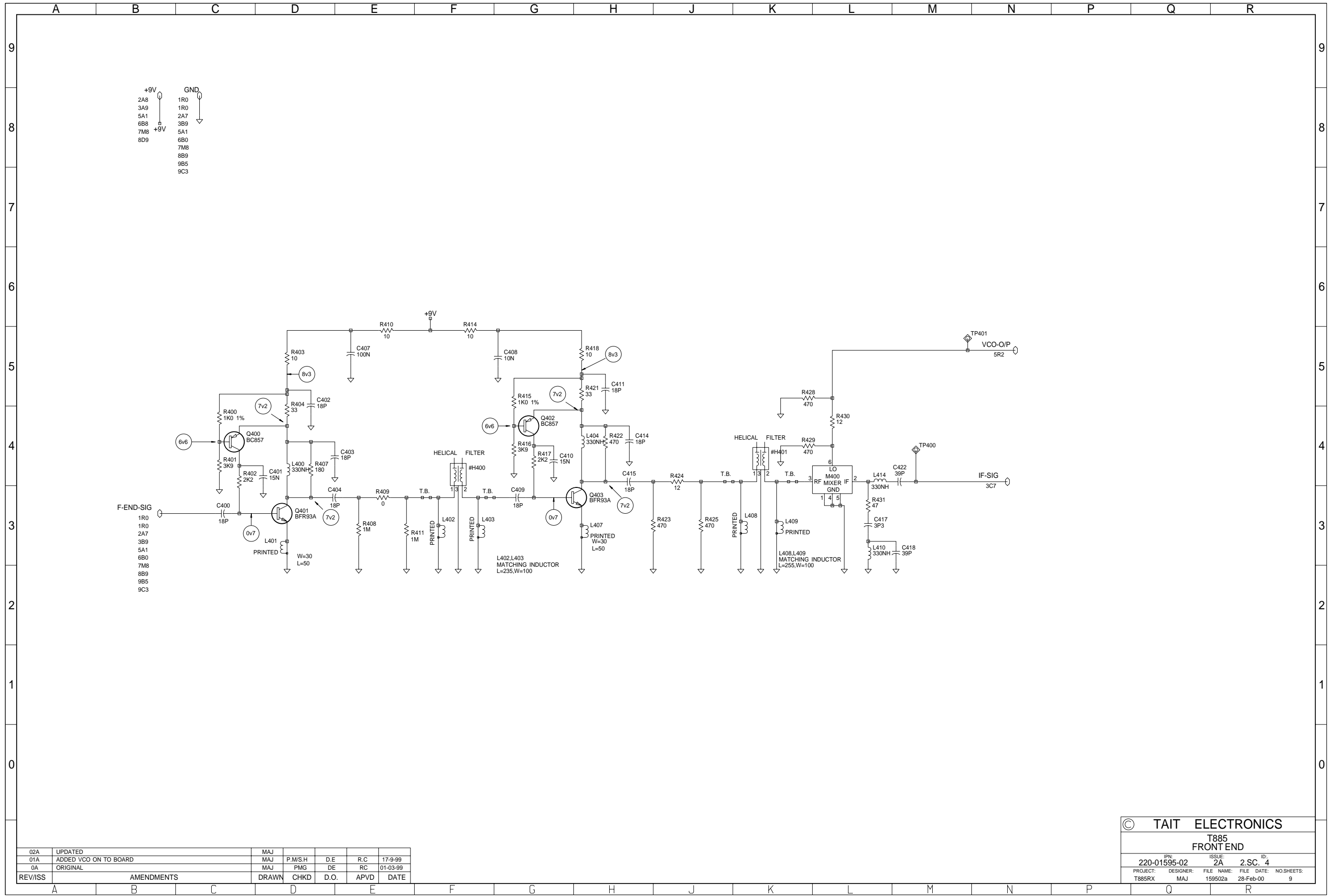

+9V
2A8
3A9
5A1
6B8
7M8
8D9

GND
1R0
1R0
2A7
3B9
5A1
6B0
7M8
8B9
9B5
9C3

02A	UPDATED	MAJ				
01A	ADDED VCO ON TO BOARD	MAJ	P.M/S.H	D.E	R.C	17-9-99
0A	ORIGINAL	MAJ	PMG	DE	RC	01-03-99
REV/ISS	AMENDMENTS	DRAWN	CHKD	D.O.	APVD	DATE

© TAIT ELECTRONICS					
T885 FRONT END					
IPN	ISSUE	ID			
220-01595-02	2A	2.S.C. 4			
PROJECT:	DESIGNER:	FILE NAME:	FILE DATE:	NO.SHEETS:	
T885RX	MAJ	159502a	28-Feb-00	9	

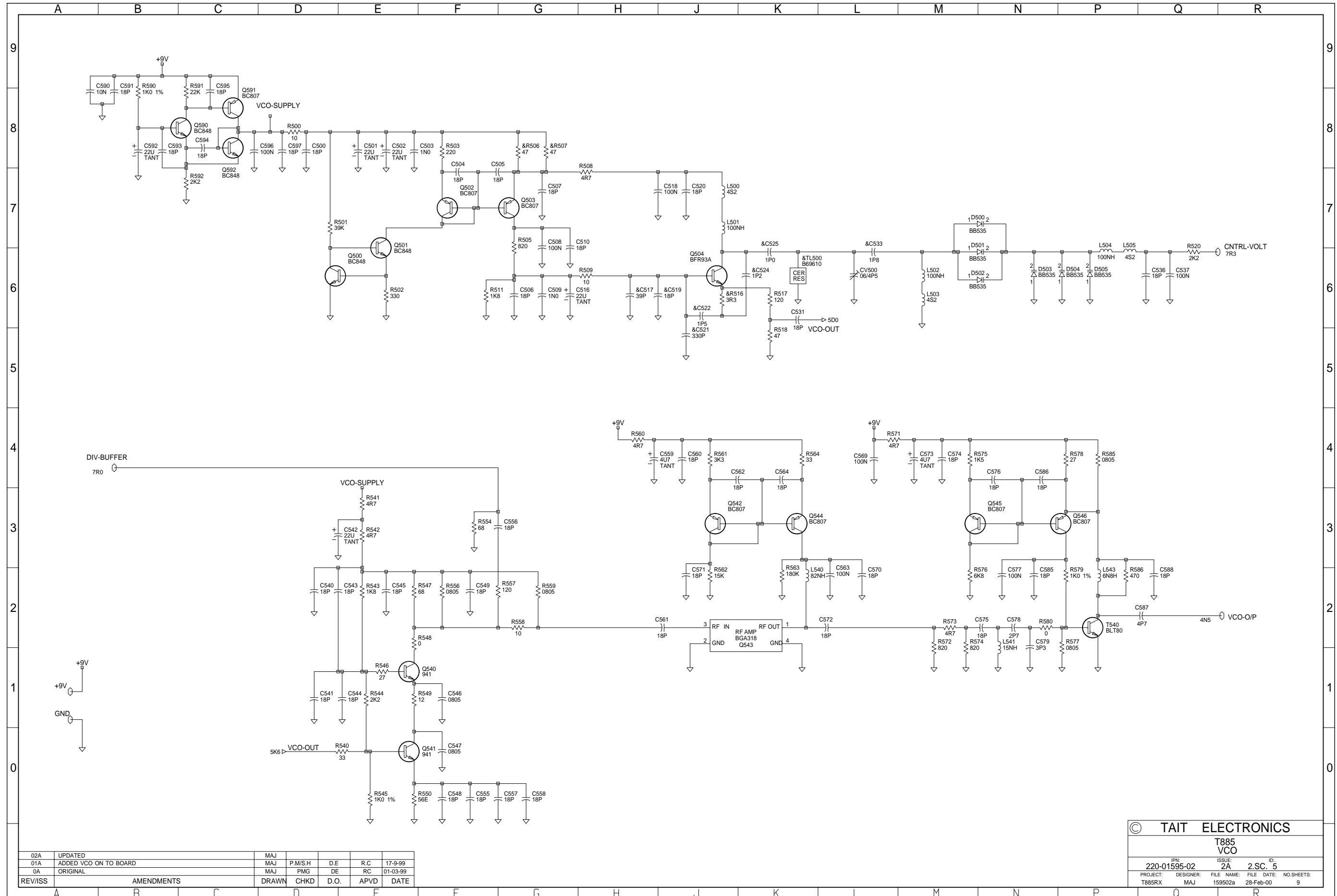

02A	UPDATED	MAJ				
01A	ADDED VCO ON TO BOARD	MAJ	P.M/S/H	D.E	R.C	17-9-99
0A	ORIGINAL	MAJ	PMG	DE	RC	01-03-99
REV/ISS	AMENDMENTS	DRAWN	CHKD	D.O.	APVD	DATE

© TAIT ELECTRONICS	
T885 VCO	
IPN: 220-01595-02	ISSUE: 2A
PROJECT: T885RX	DESIGNER: MAJ
FILE NAME: 159502a	FILE DATE: 28-Feb-00
NO SHEETS: 9	2.S.C. 5

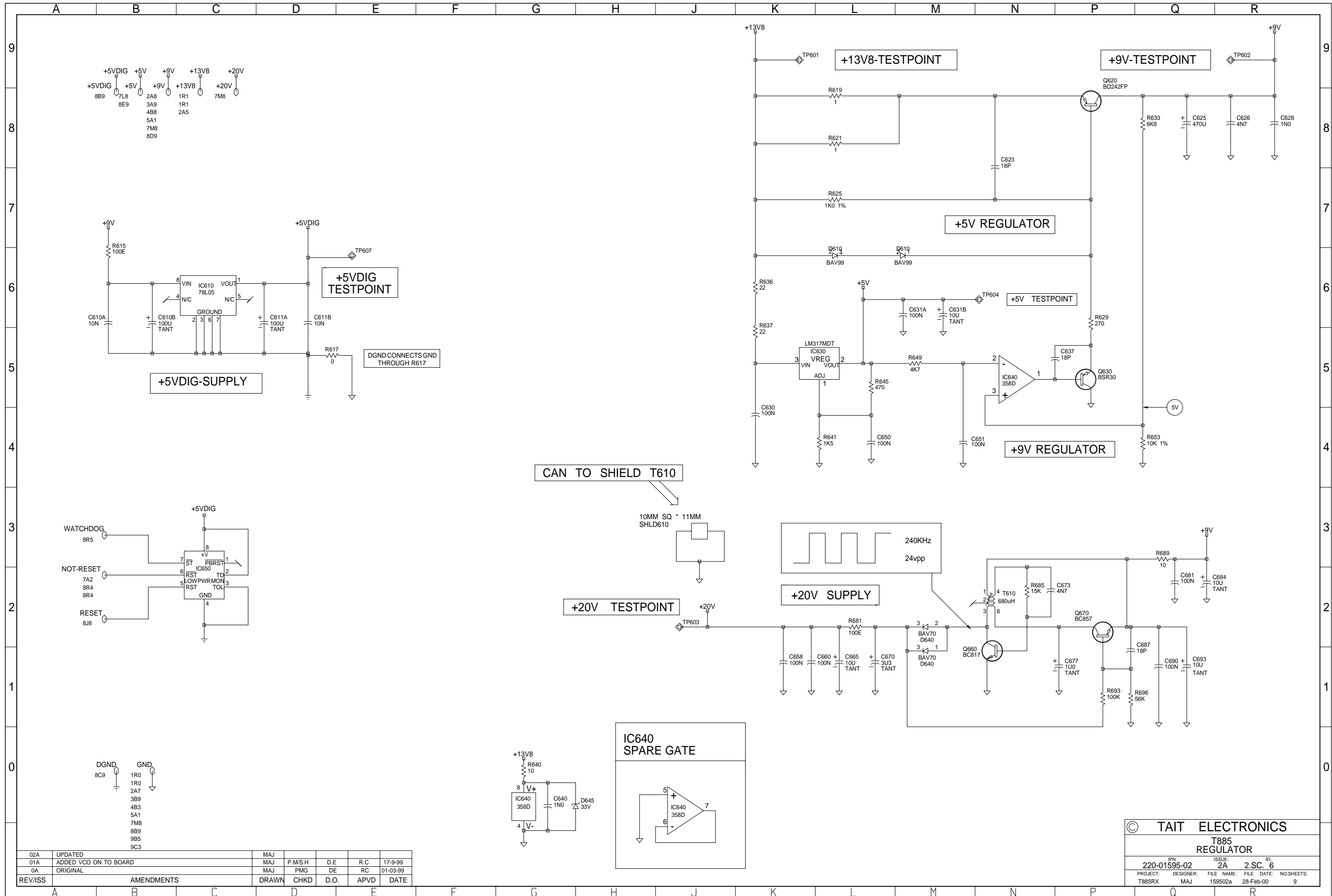

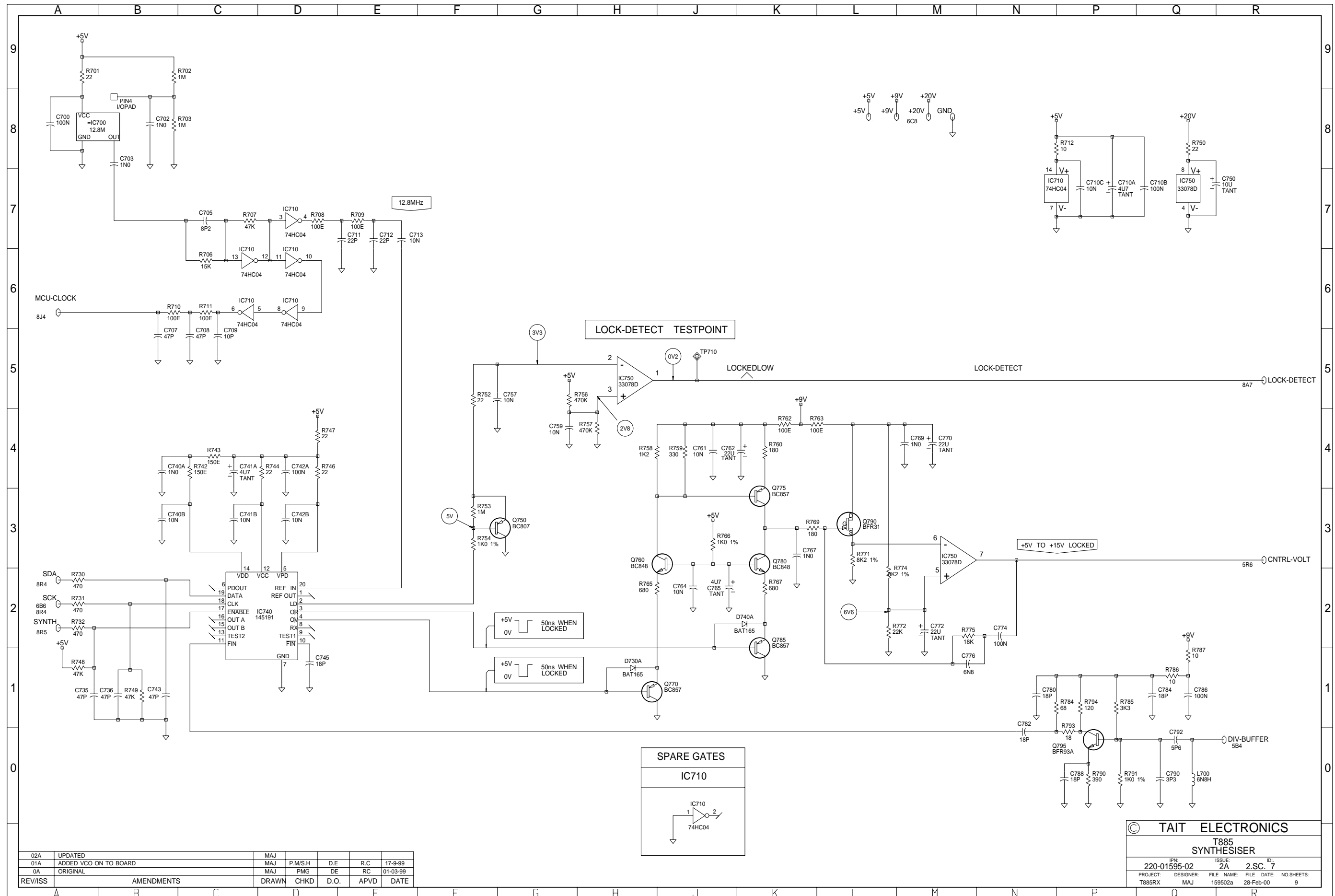

02A	UPDATED	MAJ				
01A	ADDED VCO ON TO BOARD	MAJ	P.M/S/H	D.E	R.C	17-9-99
0A	ORIGINAL	MAJ	PMG	DE	RC	01-03-99
REV/ISS	AMENDMENTS	DRAWN	CHKD	D.O.	APVD	DATE

© TAIT ELECTRONICS			
T885 SYNTHESISER			
IPN:	ISSUE:	2A	ID: 7
220-01595-02	DESIGNER:	MAJ	159502a
PROJECT:	FILE NAME:	FILE DATE:	NO.SHEETS:
T885RX	MAJ	159502a	28-Feb-00 9

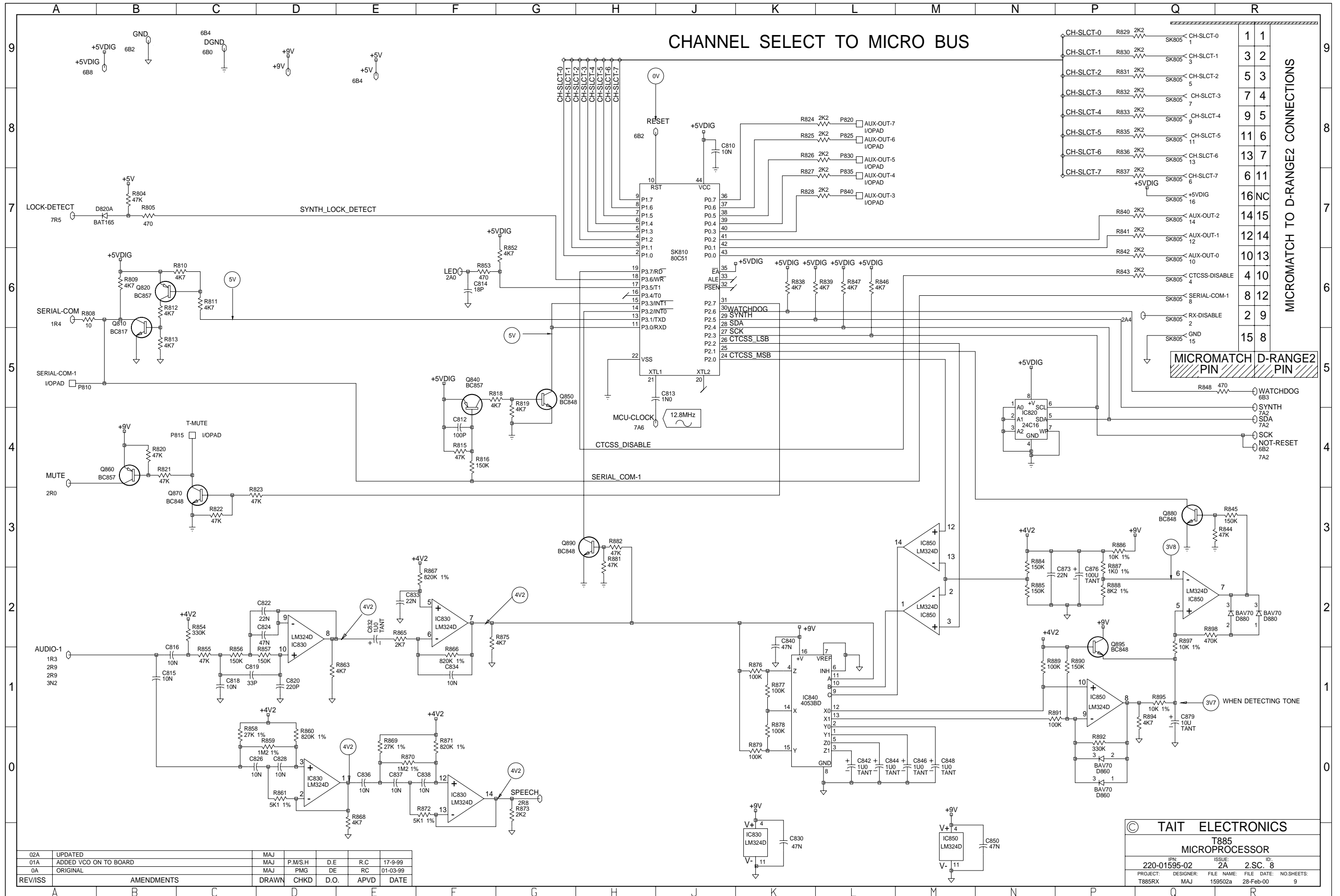

02A	UPDATED	MAJ					
01A	ADDED VCO ON TO BOARD	MAJ	P.M/S.H	D.E	R.C	17-9-99	
0A	ORIGINAL	MAJ	PMG	DE	RC	01-03-99	
REV/ISS	AMENDMENTS	DRAWN	CHKD	D.O.	APVD	DATE	

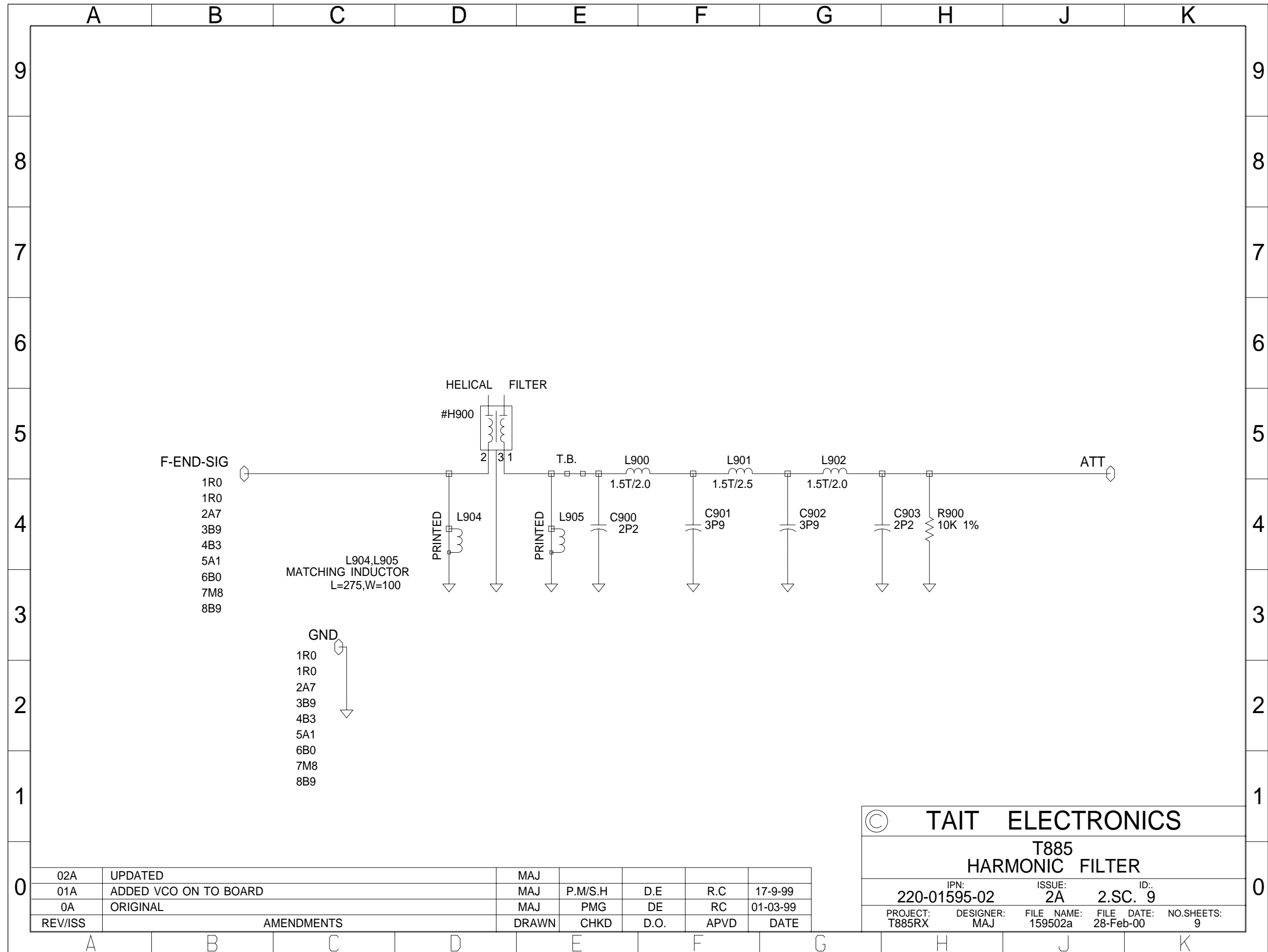

02A	UPDATED	MAJ				
01A	ADDED VCO ON TO BOARD	MAJ	P.M/S.H	D.E	R.C	17-9-99
0A	ORIGINAL	MAJ	PMG	DE	RC	01-03-99
REV/ISS	AMENDMENTS	DRAWN	CHKD	D.O.	APVD	DATE

© **TAIT ELECTRONICS**

**T885
 HARMONIC FILTER**

IPN: 220-01595-02 ISSUE: 2A ID: 2.SC. 9

PROJECT: T885RX DESIGNER: MAJ FILE NAME: 159502a FILE DATE: 28-Feb-00 NO.SHEETS: 9

